

# Operating Manual

## *Nursing Beds*

with Dewert® drive system

GB



*Casa Med Classic (FS)*

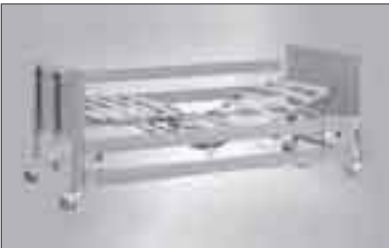

*Casa Med Ultra*



*Casa Med Classic (FS) Low*



19749GWBE

***casabeds***<sup>TM</sup>



## Table of Contents

<b>1 Preface</b> .....	2
1.1 Introduction .....	2
1.2 Information regarding this operating manual .....	2
1.2.1 Symbols used in this operating manual .....	2
1.2.2 Information regarding this operating manual .....	2
<b>2 Safety</b> .....	2
2.1 Safety information .....	2
2.1.1 Safety information – General .....	2
2.1.2 Safety information – Electrical fittings .....	3
2.1.3 Safety information – Nursing personnel, carers and users .....	3
2.1.4 Safety information – Nursing bed assembly .....	3
2.1.5 Safety information – Maintenance and inspection .....	4
2.2 Safety devices/guards .....	4
2.2.1 Safety devices/guards – Control unit .....	4
2.2.2 Safety devices – Head/backrest adjustment emergency unlocking .....	4
2.3 Safety measures .....	5
2.3.1 Safety measures – Limitations of use .....	5
2.3.2 Safety measures – Gap dimensions and bed rail spacing .....	5
2.3.2A Safety Measures – Mattress Selection .....	5
2.3.3 Safety measures – Locking (disabling) the handset .....	5
2.4 Intended use .....	5
<b>3 Delivery scope</b> .....	6
3.1 Transport and storage system .....	6
3.2 Delivery scope – List .....	6
<b>4 Assembly/set-up, dismantling, storage</b> .....	7
4.1 Nursing bed – Installation site .....	7
4.2 Nursing bed – Designation of components .....	7
4.3 Nursing bed – Assembly/set-up .....	7
4.3.1 Fitting the mattress support .....	8
4.3.2 Fitting the actuator motors .....	9
4.3.3 Connecting the handset and actuator motor for the foot section .....	9
4.3.4 Fitting the bed ends (headboard and footboard)10	
4.3.5 Connecting the bed end actuator motors .....	11
4.3.6 All control unit connections at a glance .....	11
4.3.7 Fitting the patient lifting pole .....	11
4.3.8 Routing the mains cable .....	12
4.4 Rechargeable battery (option) .....	12
4.4.1 Rechargeable battery – General information .....	12
4.4.2 Rechargeable battery – Charging .....	12
4.4.3 Rechargeable battery – Fitting .....	12
4.5 Performing a function test .....	12
4.6 Nursing bed – Dismantling .....	13
4.7 Nursing bed – Storage with the transport and storage system .....	13
<b>5 Handset</b> .....	13
5.1 Handset – Information on the variants .....	13
5.2 Handset – IPROXX .....	13
5.3 Handset with magnetic key .....	15
5.3.1 Handset – Unlocking (enabling) .....	15
5.3.2 Handset – Locking (disabling) .....	15
5.3.3 Handset – Nurse mode .....	15
5.4 Handset with mechanical key .....	15
5.4.1 Handset – Lock-out mode .....	15
5.4.2 Handset – Nurse mode .....	15
5.4.3 Handset – Patient mode .....	15
5.4.4 Handset – Programming mode .....	15
5.5 Programming the handset .....	16
<b>6 Operation</b> .....	16
6.1 Operation – General information .....	16
6.2 Operation – Mains cable, mains plug, wall socket .....	17
6.3 Operation – Raising/lowering the lower leg support .....	17
6.3.1 Raising the lower leg support .....	17
6.3.2 Lowering the lower leg support .....	17
6.4 Operation – Wheel brakes .....	17
6.5 Operation – Moving the nursing bed .....	18
<b>7 Cleaning and disinfection</b> .....	19
7.1 Nursing bed – Cleaning .....	19
7.2 Nursing bed – Disinfection .....	19
<b>8 Maintenance and inspection</b> .....	19
8.1 Maintenance – Daily .....	19
8.2 Maintenance – Every six months .....	19
8.3 Maintenance – Safety inspections .....	19
8.3.1 Testing intervals .....	19
8.3.2 Safety inspections – Mechanical components .....	19
8.3.3 Safety inspections – Electrical components .....	20
8.3.4 Safety inspections – Measurement in accordance with BGV A3 .....	21
<b>9 Trouble Shooting</b> .....	22
<b>10 Reuse</b> .....	22
<b>11 Disposal</b> .....	22
<b>12 Appendix</b> .....	23
12.1 Technical data .....	23
12.1.1 Technical data – Nursing bed .....	23
12.1.2 Technical data – Drive system .....	23
12.1.3 EMC Tables .....	24-31
12.2 Name plate .....	32
12.2.1 Name plate – Nursing bed .....	32
12.3 Accessories and options .....	33
12.4 Spare parts .....	33
<b>13 Warranty information</b> .....	33



# 1 Preface

## 1.1 Introduction

All Casabeds are manufactured with state-of-the-art technical facilities to provide maximum lying and operating comfort. Furthermore, the beds have been designed to ensure simple handling and operation. The use of attractive wood decors creates a homely atmosphere.

A large number of useful accessories round off our range of nursing beds.

The nursing beds described in this manual are constructed to the following standards:

- DIN EN 60601-2-52 (standard for hospital beds)

As the motor system of the nursing bed does not have a control system with a clock frequency of > 9 kHz and is mainly used for only brief periods of time, EN 55014-1 applies in accordance with EN 60601-1-2 36.201.1.4.

This operating manual will familiarise you with the functions of the nursing bed and, in addition, describes

- how to set up the nursing bed,
- how to operate the adjustment controls,
- how to look after and maintain the nursing bed.

The nursing bed version shown is only intended to explain how to operate the bed, and may vary from your particular version.

The manual has been drawn up using information available at the time of printing with regard to the design and operation of the nursing bed.

We reserve the right to make changes due to technical improvements.

If you have any questions regarding the nursing bed, please contact your Devilbiss Healthcare specialist dealer (see dealer stamp on the back cover)

## 1.2 Information regarding this operating manual

### 1.2.1 Symbols used in this operating manual

This operating manual contains the following symbols which are used to show you specific risks when dealing with the product or information on how to simplify handling.



#### **Caution!**

*This symbol identifies safety information which notifies you of hazards when dealing with the product.*



#### **Caution!**

*This symbol identifies safety information which notifies you of crushing and pinch point hazards when dealing with the product.*



#### **Note**

*This symbol identifies useful information on handling the product.*

### 1.2.2 Information regarding this operating manual

Thoroughly read the entire operating manual prior to setting up and using the nursing bed!

Ensure that:

- the entire operating manual is read by all persons entrusted with the setting up, operation or maintenance of the nursing bed.
- all persons entrusted with the setting up, operation or maintenance of the nursing bed have access to this operating manual at all times.

Any damage resulting from non-observance of this operating manual is excluded from the warranty.

The illustrations contained in this manual show examples of how to handle the Casabeds and may differ from your particular model.

## 2 Safety

### 2.1 Safety information

#### 2.1.1 Safety information – General



#### **Risk of accidents!**

- *Always check that the cabling is in perfect working order and that the strain reliefs are functioning before use.*
- *Only use the nursing bed for its intended purpose. Nursing beds must not be used as ladders, gym apparatus or toys.*
- *For the maximum safe working load, see Chapter "12.1.1 Technical data – Nursing bed" from page 21.*
- *Only use this nursing bed when it is in perfect working order.*
- *Always lower the nursing bed to its lowest height when it is unsupervised.*
- *It is imperative that you always rectify any faults which could influence the function and safety of the nursing bed immediately.*
- *Always secure the nursing bed against rolling by engaging the wheel brakes. Always engage all four wheel brakes on the nursing bed.*
- *Only use accessories approved by Drive Devilbiss.*
- *Always check that the mains cable, the mains plug and wall socket are in perfect working order before plugging the bed in.*

## 2.1.2 Safety information – Electrical fittings



### **Risk of short circuit and fire!**

- Always ensure that the power cable (mains cable) cannot be run over when moving the nursing bed or bedside tables, or when using cleaning equipment.
- Always check the cabling for correct positioning before use; pinching or kinking of the cable must be avoided.
- Always disconnect the mains plug before long periods of non-use.

## 2.1.3 Safety information – Nursing personnel, carers and users



### **Risk of accidents!**

- Do not use electrical medical appliances on patients in these nursing beds involving intravascular or intracardiac connection.
- Do not use the nursing bed in the vicinity of strong electromagnetic fields (for example major medical equipment).
- Always plug the nursing bed mains plug into a separate wall socket.
- Plug the mains plug into wall sockets that are easily accessible at all times.
- Route the mains cable to the wall socket in such a way that there is no mechanical tension, and the mains cable cannot be pinched, kinked or run over.
- Please observe the respective equipment operating and assembly instructions with regard to any additional safety risks that may arise when using the nursing bed in conjunction with other equipment. If you have any questions, please contact your Drive Devilbiss specialist dealer (see dealer stamp on the back cover).



### **Danger to life and risk of injury due to trapping/pinching!**

- When the bed is placed into service, or if the occupant is changed, a risk assessment must be carried out by the carer/nursing staff.
- All bed gap conditions must be considered relative to the occupant's head and body dimensions and any risk of entrapment must be identified and eliminated.
- Bed rail buffer pads are available as an accessory from Drive Devilbiss to help reduce the risk of entrapment.
- Ensure that the bed rails are always properly locked in place.



### **Possible danger to life due to alteration of the patient's position!**

- Always lock (disable) all handset adjustment functions on the handset which could cause danger to the patient's health if adjusted (consult doctor).
- Always take account of the patient's condition when locking (disabling) the adjustment options



### **Accident hazard due to falling out of the bed!**

Always move the nursing bed to the lowest height when unsupervised or for the patient to get in or out of the bed.



### **Risk of short circuit and fire!**

- Before moving the nursing bed, disconnect the mains plug and secure the mains cable from being run over.
- Do not use the nursing bed in surroundings in which flammable gases or vapours (e.g. from anaesthetics) may be present.



### **Danger due to actuator motor overheating!**

- Before adjusting the bed height, ensure that nothing is blocking the full adjustment movement.
- Avoid operating the actuator motors continuously for more than two minutes.  
Maximum continuous operation of the actuator motors = 2 minutes  
Minimum pause after 2 minutes operation = 18 minutes
- Never use more than two actuator motors simultaneously.

## 2.1.4 Safety information – Nursing bed assembly



### **Risk of injury due to incorrect assembly!**

- Ensure that all nursing bed components are correctly assembled, see page 7.
- Check that all adjustment options are in perfect working order after assembly, see page 12.



### **Risk of accidents!**

- Only perform assembly work using suitable tools.
- Only perform the work described if you are familiar with handling the required tools.



### **Pinching hazard! Crushing hazard!**

- There is increased risk of trapping (pinching or crushing) at all joints of the nursing bed and at the support points of the mattress support. The respective hazard points on the nursing bed are identified by a sticker on the lift motors at the ends of the nursing bed.
- If the mattress support sections have been folded up, secure them against unintentional unfolding by suitable methods.

### 2.1.5 Safety information – Maintenance and inspection

Only allow maintenance and inspection work to be carried out by or under the supervision and guidance of trained expert personnel who, on the basis of their specialist training, knowledge and experience - in addition to knowledge of all the relevant regulations - are capable of evaluating the condition of the nursing bed and of recognising any possible effects and hazards.

Always read the relevant chapters of this manual thoroughly before carrying out maintenance and inspection work.

Any damage resulting from non-observance of this operating manual are excluded from any liability of the manufacturer.

#### **Caution!**

- Always carry out a function test following maintenance work and inspections, see page 13.
- When operating the actuator motors, ensure that the nursing bed cabling cannot be pinched, overstretched or kinked.

#### **Hazards due to electrical and mechanical faults!**

- Immediately remove faulty/defective nursing beds from operation and secure them against unauthorised use. Disconnect the mains plug from the wall socket.
- Only use original spare parts from Drive Devilbiss
- Always carry out the prescribed maintenance and inspection work at the specified intervals, see Chapter "8 Maintenance and inspection" from page 19.
- Do not carry out any alterations to the electrical or mechanical fittings supplied with the nursing bed unless authorised to do so by the manufacturer. Unauthorised alterations lead to any liability of the manufacturer becoming null and void.
- Only perform maintenance and inspection work using suitable tools.
- Do not open electrical components.

## 2.2 Safety devices/guards

### 2.2.1 Safety devices/guards – Control unit

As an overload protection, the control unit includes the following safety devices/guards:

- Limit switches turn off the actuator motors when they reach their limit position.
- A thermal switch turns off the control unit if it overheats. The control unit can be operated again after a pause of between 20 and 30 minutes.



#### **Caution!**

- The nursing bed is not fitted with a separate Emergency Stop switch.
- In cases of emergency, disconnect the mains plug from the power supply.
- If the nursing bed is fitted with a rechargeable battery, the movement may be continued even if the mains plug is disconnected. In this case, disconnect the cable of the rechargeable battery from the control unit.

### 2.2.2 Safety devices – Head/backrest adjustment emergency unlocking

If the actuator motor should break down, the nursing bed head/backrest can be lowered manually by removing a quick-release fastening on the actuator motor.

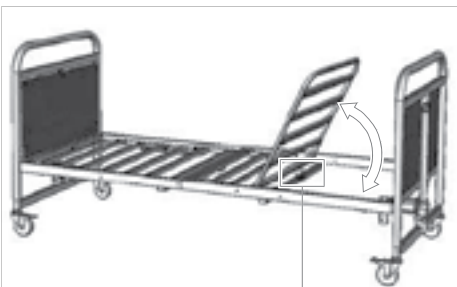

## Head/backrest adjustment – Emergency unlocking and lowering



### **Risk of injury!**

Emergency unlocking of the head/backrest adjustment must be carried out by two people.

1. (Person 1)  
Raise the mattress support head/backrest section.
2. (Person 2)  
Remove the quick-release fastening on the lift bar as follows:
  - Open the bolt retainer.
  - Pull the quick-release bolt out of the fixture.
3. Slowly lower the mattress support head/backrest section.

## Head/backrest adjustment – Putting back into operation

1. Ensure that the actuator motor is functioning correctly.
2. Set the lift bar on the actuator motor so that the quick-release bolt can be inserted again.
3. Refit the quick-release fastening.

## 2.3 Safety measures

### 2.3.1 Safety measures – Limitations of use

Particular patient illnesses or clinical conditions can lead to limitations being imposed on the nursing bed application capabilities.

Before using the nursing bed, consult the specialist responsible for the patient.

Due to their design, Casabeds are only approved for occupants over 12 years of age or for occupants with body size and weight equivalent to an average 12 year old.

Casabeds must not be used for persons under 45 kg body weight or under 150 cm's height, or for person that suffer from spasms or are confused.

### 2.3.2 Safety measures – Gap dimensions and bed rail spacing



### **Danger to life and risk of injury due to trapping/pinching!**

- When the bed is placed into service, or if the occupant is changed, a risk assessment must be carried out by the carer/nursing staff.
- All bed gap conditions must be considered relative to the occupant's head and body dimensions and any risk of entrapment must be identified and eliminated.
- Bed rail buffer pads are available as an accessory from Drive Devilbiss to help reduce the risk of entrapment.
- Ensure that the bed rails are always properly locked in place.

The following checks must be made on the nursing bed and suitable preventive measures taken – particularly in the case of extremely thin patients –

#### **Check:**

That it is not possible for the patient to slip between the mattress and the bed rails.

#### **Preventative measure:**

Only use mattresses that have the same reclining surface width as the bed (90 cm).

### 2.3.2A Safety Measures – Mattress Selection

When selecting a mattress, the distance between the top of the mattress (without compression) to the top edge of the side rails should be greater than 220mm.

### 2.3.3 Safety measures – Locking (disabling) the handset



### **Possible danger to life due to alteration of the patient's position!**

- Always lock (disable) the nursing bed adjustment functions on the handset, see page 14, and/or see page 15, which could endanger the patient (consult the specialist responsible for the patient).
- Test the lock-out function of the handset by operating the function keys. Ensure that no adjustments are performed when the keys are pressed.
- Replace the handset or the control unit if it does not function correctly.

## 2.4 Intended use

Casabeds have been designed in accordance with DIN EN 60601-2-52 for continuous use by the disabled.

Casabeds are designed to:

- alleviate/compensate for a disability or inability of patients
- make the working conditions of nursing personnel easier.

Casabeds can also be used for the diagnosis, treatment or observation of patients under medical supervision in accordance with DIN EN 60601-2-52 in home care, nursing homes or similar environments.

The nursing beds are intended for use in:

- home nursing
- nursing homes and rehabilitation centres



### **Limitations of use**

- Due to their design, Casabeds are only approved for occupants over 12 years of age.
- The nursing bed is not suitable for occupants taller than 195 cm. (Bed extensions available as an option).
- Due to their design, Casabeds are only approved for occupants over 12 years of age or for occupants with body size and weight equivalent to an average 12 year old.
- Casabeds must not be used for persons under 45 kg body weight or under 150 cm's height, or for person that suffer from spasms or are confused.

### 3 Delivery scope

#### 3.1 Transport and storage system

All components of the nursing bed are conveniently packed and fastened to a transport pallet or to the transport and storage system to form one transport unit.

Before commencing with the assembly of the nursing bed, check that the delivery is complete according to the lists specified in the following.

In the event of noticeable defects or missing components, please contact your Drive Devilbiss specialist dealer (see dealer stamp on the back cover).



1. Pull the patient lifting pole out of the mounting tube of the transport and storage system.

2. Remove all cardboard packaging.

3. Loosen all safety screws and take out the mattress support sections.

Note

Keep all cardboard packaging for possible storage of the nursing bed at a later date.

Note

The illustrations contained in this manual show examples of how to handle the Casabeds and may differ from your particular model.

#### 3.2 Delivery scope – List

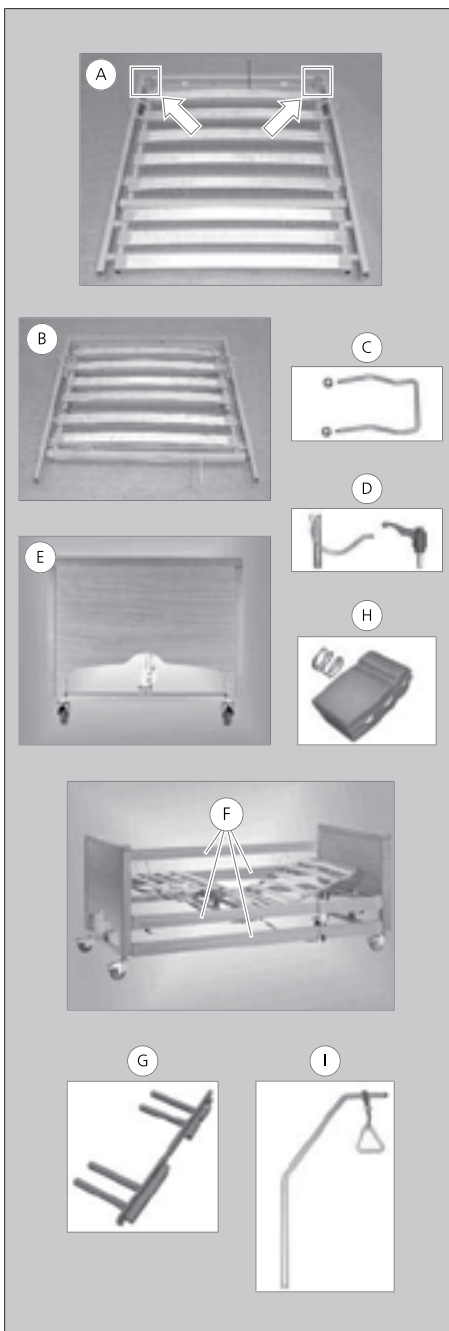

##### Mattress support and bed frame



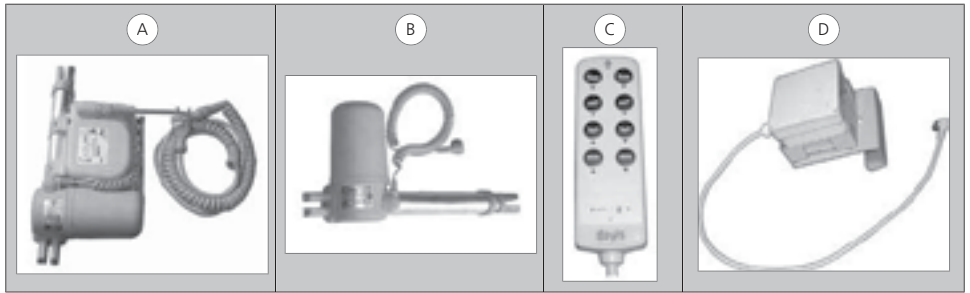

A	Mattress support head/backrest (1x) (with mount for the patient lifting pole)	F	Side rails (4)
B	B Mattress support foot section (1x)	G	Side rail carriers (4)
C	Mattress retainers (4x) (with fastening screws) In several versions, the mattress retainers are already welded to the frame.	H	Plastic end caps for side rails (8)
D	Quick-release bolts (4x), Clamping levers (6x)	I	Patient lifting pole (with strap and triangular hand grip)
E	Bed ends (2x) (with pre-assembled actuator motors)		



A	Actuator motor with control unit (1x) (for head/backrest adjustment, including dummy connectors and strain relief)
B	Actuator motor (1x) (for foot section adjustment)
C	Handset (1x) (including magnetic key and/or mechanical key)  <b>Note</b> Various handset versions are available – depending on the specification.
D	Rechargeable battery (1x) (option) (including support and fastening screw)  <b>Note</b> The rechargeable battery is only required for nursing beds with Trendelenburg position.

## 4 Assembly/set-up, dismantling, storage

### 4.1 Nursing bed – Installation site

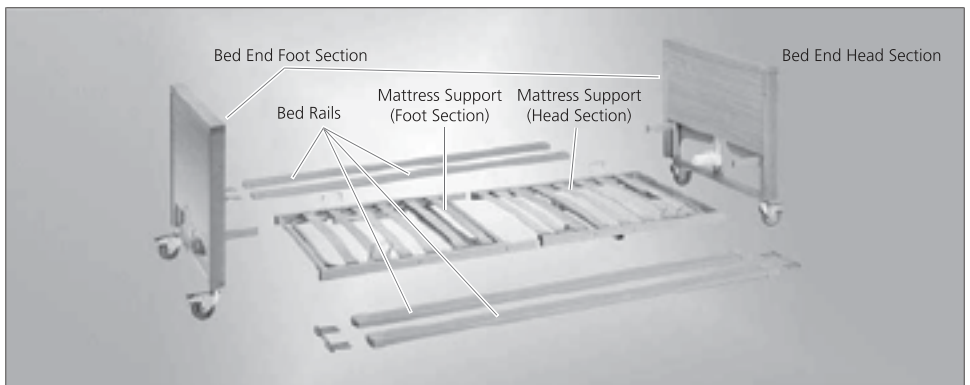

## 4.2 Nursing bed – Installation site

When selecting the bed's location, ensure that there is sufficient space for access to the patient in the bed on at least one of the bed's sides and that there is a power socket conveniently located nearby.

The illustration shows the required dimensions for setting up the bed and additional space required for access to the patient.

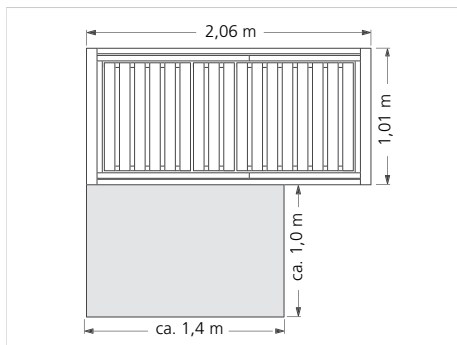

## 4.3 Nursing bed – Assembly/set-up

### Note

- The nursing bed can be assembled by one person. Once the components have been unpacked, assembly takes approx. 15 minutes.
- The specifications "right-hand" and "left-hand" refer to the nursing bed as seen from the foot end.

### 4.3.1 Fitting the mattress support

1. Insert the four mattress retainers (A) into the holes (B) in the frame of the mattress support and screw tight.

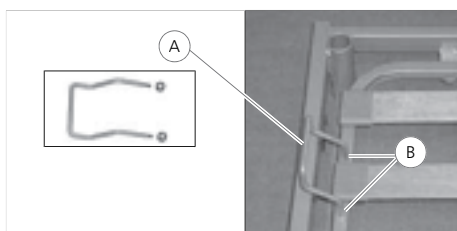

2. Lean the foot section (C) of the mattress support against an empty wall with the underside facing away from the wall.
3. Fit the head/backrest (D) onto the mattress support.



### Crushing hazard!

- There is increased risk of trapping (pinching or crushing) at all joints of the nursing bed and at the support points of the mattress support.
- Secure adjustable joints against unintentional folding up/unfolding by suitable methods.

4. Insert two clamping levers (E) into the holes and screw tight. Ensure that the clamping levers do not point outward when screwed tight.

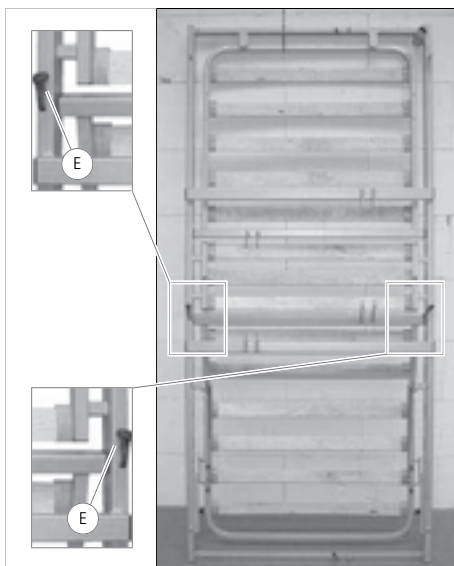
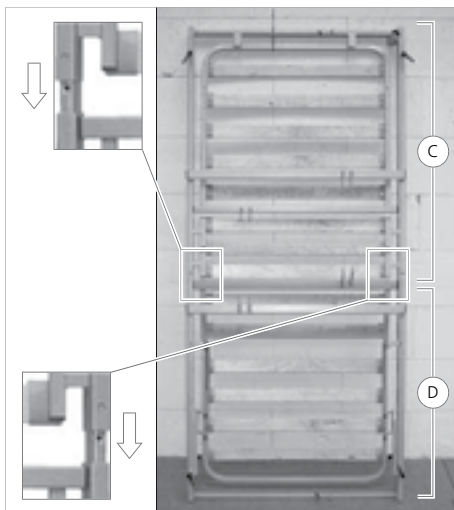

### 4.3.2 Fitting the actuator motors

Two actuator motors have to be fitted to the mattress support.

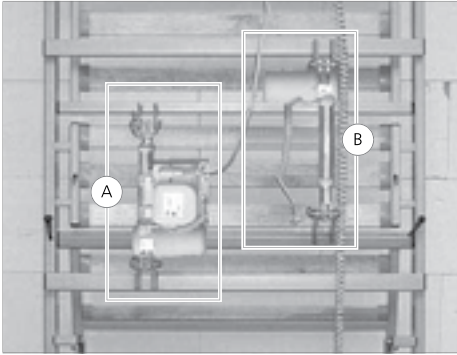

A	Actuator motor with control unit (for head/backrest adjustment)
B	Actuator motor (for foot section adjustment)

1. If actuators are not pre-assembled, fit the actuator motor with control unit (A) so that the flat side of the motor points towards the wood or metal mattress support and the lift bar (C) towards the head/backrest.



**Caution!**

It is imperative that the actuator motors are fitted in the correct direction (label on the nursing bed).

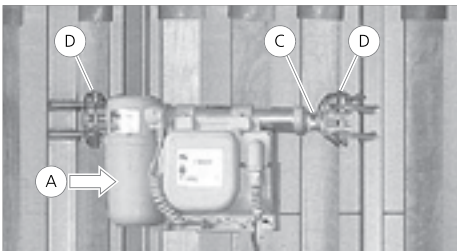

2. Fasten the actuator motor with control unit to the supports on the frame using the quick-release bolts (D).
3. Close the quick-release bolt retainers.



**Note**

Chose the location for screw attachment according to the position of the wall power socket.

4. Create a loop in the mains lead and feed through the strain relief as shown below:-

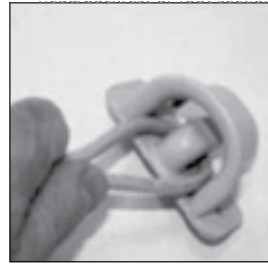

**Caution!**

It is imperative that the actuator motors are fitted in the correct direction (label on the nursing bed).

5. Fit the second actuator motor (B) such that the motor points to the centre of the mattress support and the lift bar (F) towards the foot section.

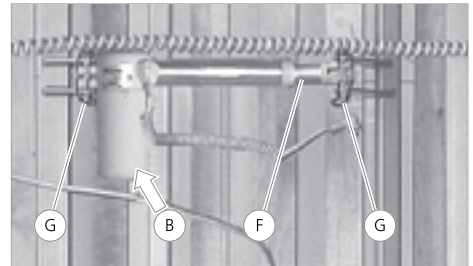

6. Fasten the actuator motor to the supports on the frame using the quick-release bolts (G).
7. Close the quick-release bolt retainers.

### 4.3.3 Connecting the handset and actuator motor for the foot section

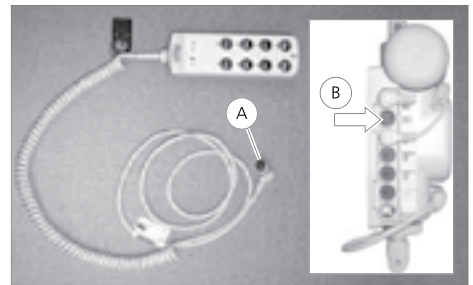

**Note**

- The actuator motor with control unit is connected to the control unit in the factory.
- When inserting the connectors, take care not to damage the connector sealing rings.



1. Remove the dummy connectors.
2. Insert the handset connector (A) into the socket (B) of the control unit (red symbol). Ensure that the pins of the connector are aligned with the guide grooves on the socket.
3. Use the strain relief (C) to fasten the cable of the handset to the frame.

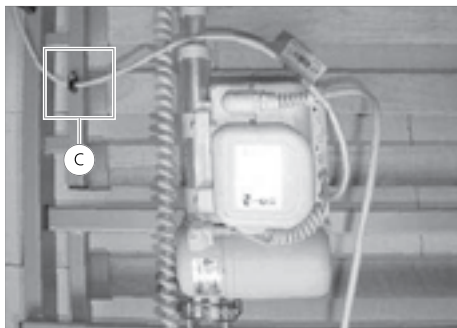

4. Insert the connector (D) of the second actuator motor into socket (E) of the control unit (yellow symbol).

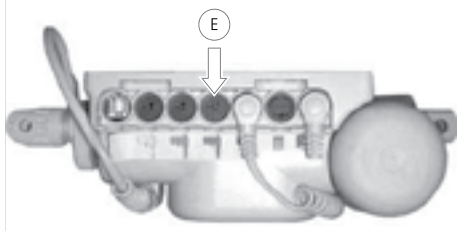
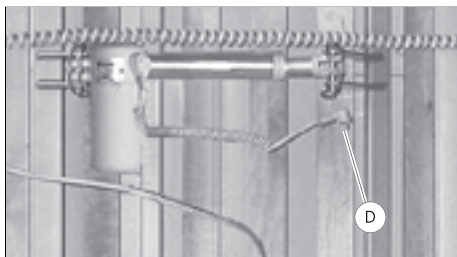

#### 4.3.4 Fitting the bed ends (headboard and foot board)



**Note**

Any connections not in use must be closed with dummy connectors.

1. Carefully place the assembled mattress support onto the floor with the actuator motors underneath.
2. Insert the frame of the mattress support into the guides of the bed end. (A)
3. Insert the clamping levers (B) into the threaded hole on each side of the frame and screw tight.
4. Fit the second bed end in the same way.

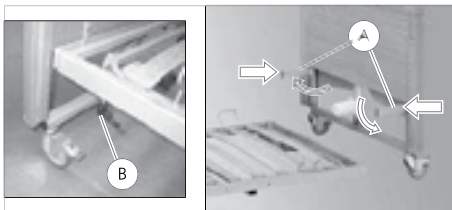

5. Undo the securing strap (C) and remove all remaining transport securing devices.

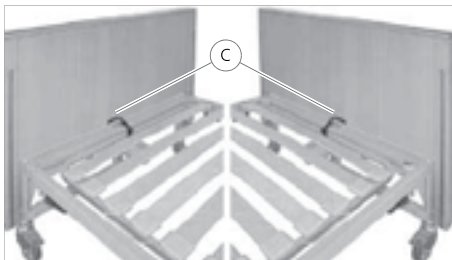

#### 4.3.5 Connecting the bed end actuator motors



**Note**

The actuator motors on the bed ends are pre-assembled in the factory.

1. Remove the dummy connectors.
2. Connect the bed end actuator motor for the headboard (blue symbol).
3. Connect the bed end actuator motor for the footboard (white symbol).
4. Any sockets not in use must be closed with dummy connectors.
5. Fit the supplied strain relief over the row of connectors.

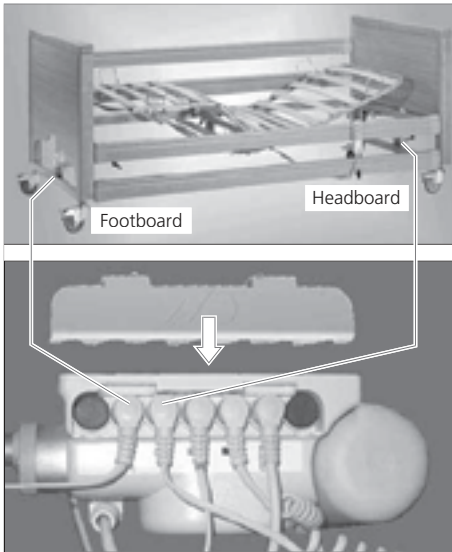

**4.3.6 All control unit connections at a glance**

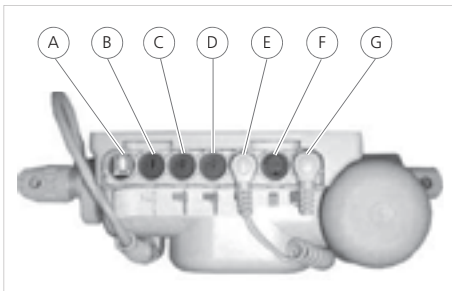

- A Rechargeable battery (option)
- B Actuator motor – bed end, footboard (white symbol)
- C Actuator motor – bed end, headboard (blue symbol)
- D Actuator motor – mattress support, foot section (yellow symbol)
- E Actuator motor with control unit – mattress support, head/backrest (black symbol)
- F Handset (red symbol)
- G Not assigned



**Note**

Any connections not in use must be closed with dummy connectors.

**4.3.8 Fitting the patient lifting pole**

1. Insert the patient lifting pole into the mount of the mattress support head end and turn it until the pole locks into place.
2. Push the hand grip strap loop (A) onto the tube of the patient lifting pole.

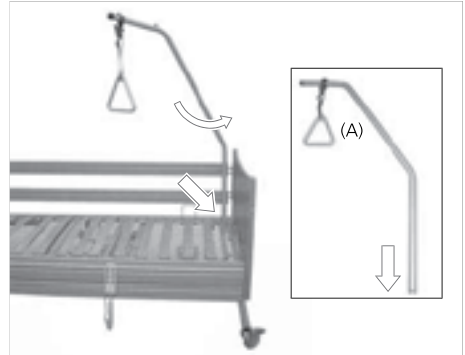

**4.3.7 Installing the bed rails**

The bed rail cappings have different drill holes in them.

- (a) top capping for bed rail = drill holes offset downwards
- (b) bottom capping for bed rail = drill holes offset upwards

**Bed rail capping drill holes**

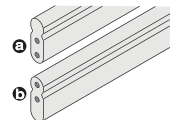

**Installing the bed rails**

Press the plastic caps (4) onto the bed rail (observe drill hole position).

Push the bed rails (a+b) onto the pegs (5) on the slider.

**NOTE**

Before pushing on, check to see that the spring is located in the cap.

Fixing the bed rail at the head end: Press bottom fastening knob (1), push the slider (2) with the point facing upwards into the guide groove (3) on the head front face and engage in top locking device

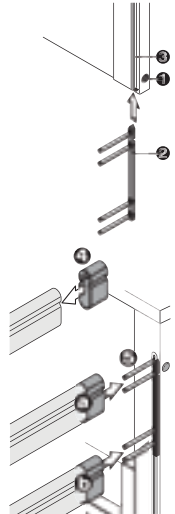

**Fixing the bed rail at the foot end:**

Press the plastic caps (1) onto the bed rail (observe drill hole position).

**NOTE**

Before pushing on, check to see that the spring is located in the cap. Die Guide the pegs (2) on the sliders into the drill holes in the cap and bed rails.

When doing this, the pointed side of the guide rail must face upwards (see sketch).

Press bottom fastening knob (3), Push the slider (4) into the guide groove on the foot front face and engage in top locking device. Install the second bed rail in the same manner as the first.

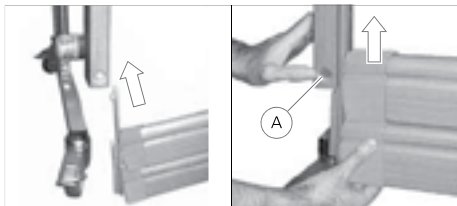
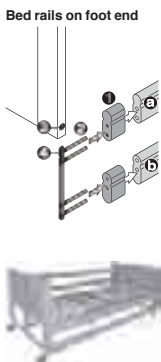

**Routing the mains cable**

When routing the cables, ensure that:

- The cables are not subjected to tension.
- The cables do not sag excessively.
- The cables are not routed in the proximity of crushing and shearing points.
- After routing the mains cable, test all the functions of the nursing bed.

**4.4 Rechargeable battery (option)**



**4.4.1 Rechargeable battery – General information**

Any adjustments of the nursing bed can be performed 5 - 15 times using the rechargeable battery (depending on the selected adjustment and weight of the patient).

**4.4.2 Rechargeable battery – Charging**

- The rechargeable battery is automatically charged when the mains plug is connected to the power supply.
- The battery has a charging time of at least 12 hours.
- A protection circuit prevents overcharging of the battery.
- Do not store the rechargeable battery for a prolonged period without charging.

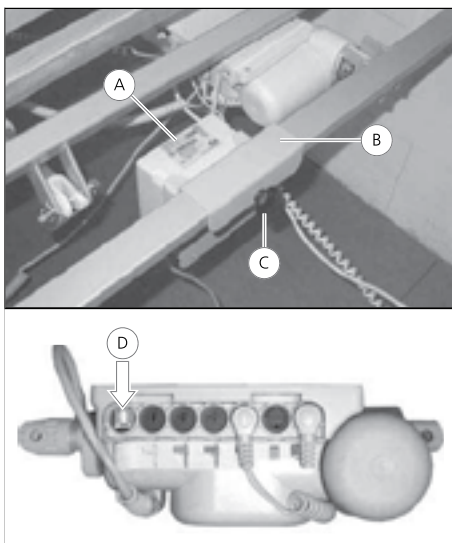

- Recharge the rechargeable battery once per month even when it is not in use.
- A warning tone signals when the battery discharge limit has been reached.

**4.4.3 Rechargeable battery – Fitting**

1. Raise the head/backrest.
2. Insert the rechargeable battery (A) into the supplied holder (B) and fasten to the frame underneath the head/backrest.
3. Tighten the clamping screw (C).
4. Connect the rechargeable battery to connection (D) of the control unit.
5. If the battery is not connected to the control box, insert the dummy plug provided.

## 4.5 Performing a function test



### Notes

- When connecting the mains plug and testing the actuator motors, observe the safety information see page 16.
  - Check that the transport securing devices have been removed from the head/backrest and foot section of the mattress support.
  - When operating the motors, ensure that the nursing bed cabling cannot be pinched or overstretched.
1. Insert the mains plug of the nursing bed into a wall socket (230V ~ / 50Hz / 60Hz). Check that all movements of the nursing bed are in perfect working order.

When testing the movements, ensure that all cables are routed with sufficient play and are not kinked or pinched.



Keep feet clear of the bed's perimeter when lowering the Classic FS Low bed. Optional handset with lockout high/low function available if there is a risk to patient.

- Move the nursing bed to the highest position.
- Move the nursing bed to the lowest position.
- Move the head/backrest to the highest position.
- Move the head/backrest to the lowest position.
- Move the foot section to the highest position.
- Move the foot section to the lowest position.

## 4.6 Nursing bed – Dismantling

Dismantle the nursing bed in the reverse order as described in Chapter "4.3 Nursing bed – Assembly/set-up" from page 7.

At the same time, take the following additional points into consideration:



### Risk of injury!

- Fasten the moving parts of the mattress support to the nursing bed frame using the securing strap to prevent injury during dismantling.
- If the mattress support sections are not secured, there is a risk of pinching and crushing.

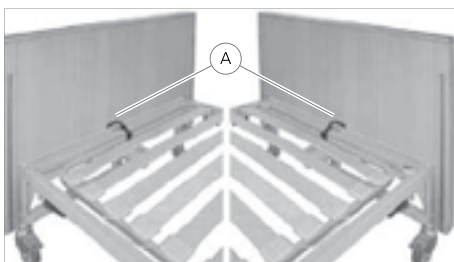

## 4.7 Nursing bed – Storage with the transport and storage system

1. Push the transport and storage system onto the bed end guides and secure with the clamping levers.
2. Secure the mattress support to the frame using the securing straps.
3. Push the mattress support foot section into the transport and storage system guides and secure with the clamping levers.
4. Push the mattress support head/backrest into the transport and storage system guides and secure with the clamping levers.
5. Pack the mattress support motor and small parts (if possible in the original box) and place upright between the mattress support sections.
6. Insert the patient lifting pole into the mount of the transport and storage system.



## 5 Handset

### 5.1 Handset – Information on the variants

All motor-powered movements of the nursing bed are performed using the handset.

The nursing bed can be equipped with various handsets.

Please refer to the white sticker on the cable for the handset designation.

The following handsets are available:

**I PROXX / SE** Standard handset without Trendelenburg position with magnetic lock-out

**I PROXX / SE+** Handset with Trendelenburg position and magnetic lock-out

**I PROXX / SM** Handset without Trendelenburg position with mechanical lock-out

**I PROXX / SM+** Handset with Trendelenburg position and mechanical lock-out

**I PROXX / SMP** Programmable handset without Trendelenburg position with mechanical lockout

**I PROXX / SMP+** Programmable handset with Trendelenburg position and mechanical lock-out

- D** Raise foot section
- E** Lower foot section
- F** Raise head/backrest and foot section
- G** Lower head/backrest and foot section
- H** Raise bed frame
- I** Lower bed frame
- J** Anti-trendelenburg position (optional)
- K** Trendelenburg position (optional)
- L** LED – Power On  
Flashing: Rechargeable battery is being charged  
Lit yellow: Rechargeable battery connected and fully charged  
Not lit: Rechargeable battery not connected (optional)
- M** LED – Lock-out (optional)  
Lit yellow: The operating keys with lit LED are enabled  
Not lit: The operating keys with extinguished LED are disabled
- S** LED – Lock-out (optional)  
Lit green: Patient mode (Trendelenburg position disabled)  
Lit orange: Nurse mode (All operating keys are enabled)  
Not lit: Handset disabled

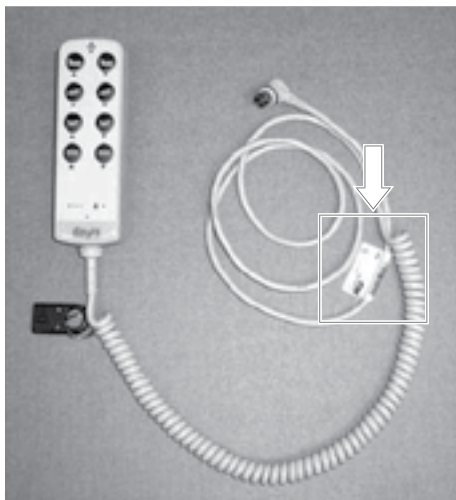

## 5.2 Handset – I PROXX



### Caution!

Observe the safety information from Chapter "2 Safety" from page 3.

- A** LED – Actuator motors  
Lit green: Actuator motor(s) active  
Not lit: Actuator motor(s) OFF
- B** Raise head/backrest
- C** Lower head/backrest

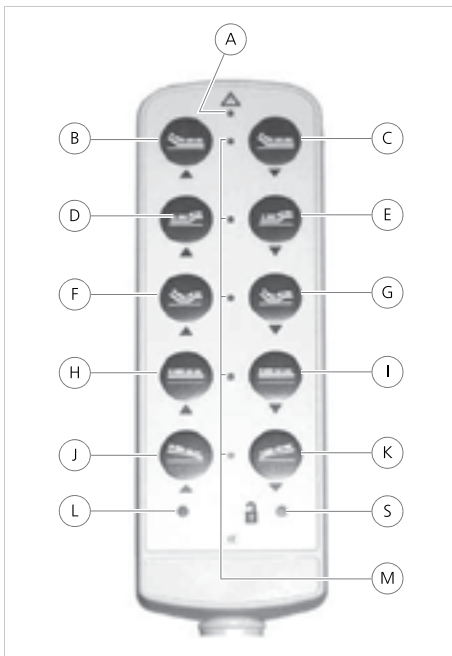



### 5.3 Handset with magnetic key

#### 5.3.1 Handset – Unlocking (enabling)



**Notes**

The handset switches automatically to lock-out mode (disabled) during initial start-up, after disconnection of the mains plug and following a power failure.

Swipe the flat end of the magnetic key over the key symbol (A) to unlock (enable) the handset.

The control lamp – LED (A) is lit yellow.

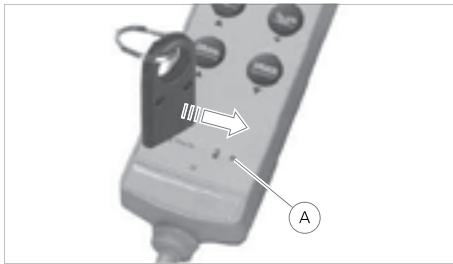

#### 5.3.2 Handset – Locking (disabling)

To lock (disable) the handset swipe the flat end of the magnetic key over the key symbol (A) when the handset is enabled.

The control lamp – LED (A) extinguishes.

If the handset is equipped with the nurse mode (LED lit orange), it is necessary to swipe the magnetic key over the key symbol (A) a second time.

#### 5.3.3 Handset – Nurse mode



**Note**

Only handset IPROXX ISMP+ is equipped with the nurse mode which can be activated with the magnetic key.

To switch the handset to nurse mode, swipe the flat end of the magnetic key twice (2x) over the key symbol (A) when the handset is in lock-out mode (disabled).

The control lamp – LED (A) is lit orange.

### 5.4 Handset with mechanical key



**Note**

Only models IPROXX SM(+) and SMP(+) have a mechanical key. All possible functions are explained in the following, however, not every handset is equipped with all functions.

The mechanical key can be used to select the different modes on the back of the handset. Insert the pentagonal end of the key into the respective hole on the back of the handset and turn the point of the arrow to the desired symbol.

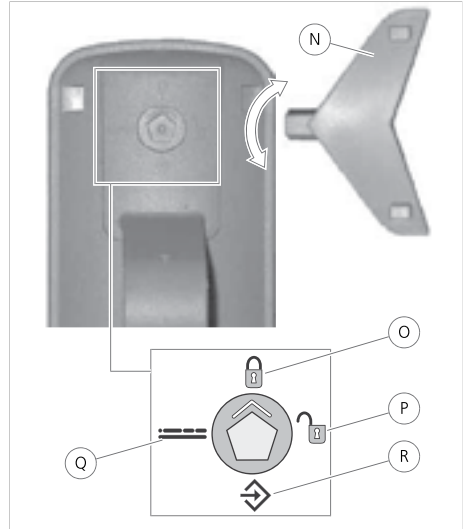

#### N Mechanical key

Key for mechanically adjusting the lock-out (on the back of the handset) Change mode: Insert key and turn to the desired position

The arrow points to the current mode

#### O Operating keys are disabled

#### P Nurse mode – All operating keys are enabled

#### Q Patient mode – All operating keys programmed for this mode are enabled

#### R Programming mode (Chapter "5.5 Programming the handset" from page 15)

#### 5.4.1 Handset – Lock-out mode



In this mode, all operating keys of the handset are disabled.

#### 5.4.2 Handset – Nurse mode



In this mode, all operating keys of the handset are enabled.

#### 5.4.3 Handset – Patient mode



In this mode, only the operating keys specified in the programming mode are enabled.

#### 5.4.4 Handset – Programming mode



In this mode, it is possible to specify which operating keys are to be disabled or enabled in patient mode.

## 5.5 Programming the handset



### Note

Only handsets "IPROXX /SMP" and "IPROXX /SMP+" are programmable.

In programming mode it is possible to specify the enabled adjustment functions for patient mode.

1. Switch the handset to the programming mode (B) using the mechanical key.
2. The current setting of the operating keys is displayed by the LEDs (A) between the respective operating key pairs.

LED lit:

Operating key pair enabled

LED not lit:

Operating key pair disabled

3. Press the key of the desired function to enable or disable the operating key pair.
4. Switch the handset to the patient mode (C) using the mechanical key.

The previously defined operating key pairs are enabled or disabled.

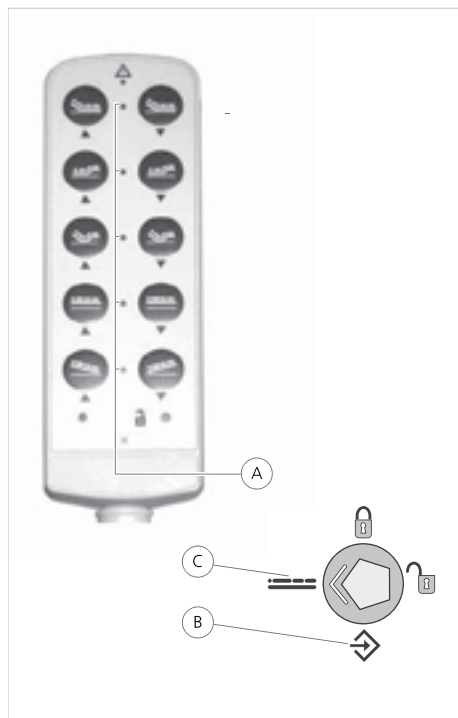

## 6 Operation

### 6.1 Operation – General information

The adjustment of the head/backrest and foot section, as well as the bed height, are infinitely variable.

- The adjustment range of the mattress support height is 40 to 80 cm. (Low beds are also available with an adjustment range of 23-63 cm)
- The head/backrest can be inclined upwards by 70°.
- The foot section can be inclined upwards by 20°.
- In addition, the lower leg support can be lowered by hand, see page 17.

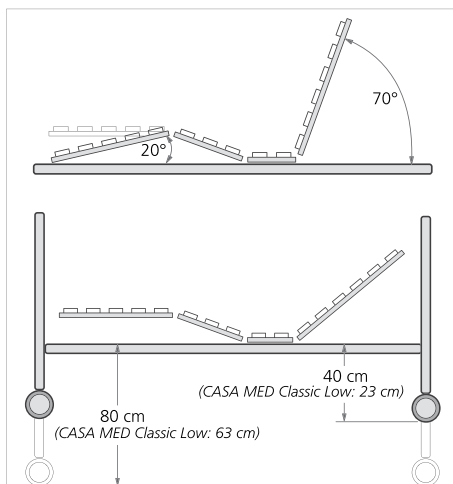

Keep feet clear of the bed's perimeter when lowering the Classic FS Low bed. Optional handset with lockout high/low function available if there is a risk to patient.



### Note

The lower leg support can only be lowered in 4-section mattress supports.



### Risk of accidents!

- Do not use medical or electrical appliances on patients in these nursing beds.
- Do not use the nursing bed in the vicinity of strong electromagnetic fields (for example major medical equipment).
- There is increased risk of trapping (pinching or crushing) at all joints of the nursing bed and at the support points of the mattress support.
- If the mattress support sections have been folded up, secure them against unintentional unfolding by suitable methods.

**When carrying out adjustments, please observe the following points:**

- Before adjusting the bed height, ensure that nothing is blocking the full adjustment movement.
- Avoid operating the actuator motors continuously for more than two minutes.

- Maximum continuous operation of the actuator motors = 2 minutes
- Minimum pause after 2 minutes operation = 18 minutes
- Never use more than two actuator motors simultaneously.
- Always move the nursing bed to the lowest height for the patient to get into or out of the bed.
- When carrying out adjustments, watch the occupant in the bed and the bed's surroundings.

## 6.2 Operation – Mains cable, mains plug, wall socket



### **Risk of accidents!**

- Always plug the mains plug into a separate wall socket (230 VAC; 50Hz/60Hz).
- The mains cable must not be run over.
- Route the mains cable in such a way that it is not subjected to tension, is not kinked, rolled over or pinched.
- Plug the mains plug into wall sockets that are easily accessible at all times.
- Always check that the mains cable, the mains plug and wall socket are in perfect working order before plugging the bed in.



### **Caution!**

- The nursing bed is not fitted with a separate Emergency Stop switch.
- In cases of emergency, disconnect the mains plug from the power supply.
- If the nursing bed is fitted with a rechargeable battery, the movement may be continued even if the mains plug is disconnected.

*In this case, disconnect the cable of the rechargeable battery from the control unit.*

## 6.3 Operation – Raising/lowering the lower leg support

The lower leg support on the foot section of the mattress support can be set by hand using an engagement system.

### 6.3.1 Raising the lower leg support

1. Grip the end frame of the foot section in the centre.
2. Raise the lower leg support slowly to the desired position until the engagement system audibly engages.

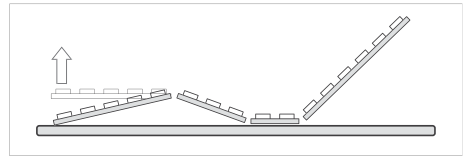

### 6.3.2 Lowering the lower leg support

1. Grip the end frame of the foot section in the centre.
2. Unlock the engagement system by raising the lower leg support to the top position.
3. Lower the lower leg support as far as the bottom stop.

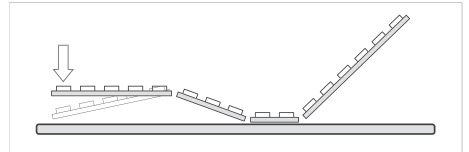

## 6.4 Operation – Wheel brakes

Each of the four swivel wheels on the nursing bed has a separate brake.

Push the brake lever (A) down to lock the brake.

Push the brake lever (B) back to release the brake.



### **Crushing hazard!**

*Before locking, turn the swivel wheels in the direction of the mattress support under the nursing bed. Ensure that the brake and release levers are easily accessible.*



## 6.5 Operation – Moving the nursing bed



### Note

- Only transport patients in a lying position.
- If the patient lifting pole is fitted, ensure that there are no low hanging objects (e.g. ceiling lamps) in the path of the nursing bed.

### Before moving

1. Move the mattress support to the lowest position.
2. Move the head/backrest to the lowest position.
3. Move the foot section to the lowest position.
4. Disconnect the mains plug from the power supply.
5. Secure the mains cable against being run over.
6. Release the wheel brakes.

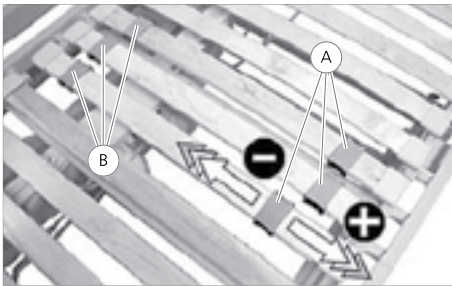

### After moving

1. Lock all wheel brakes.
2. Plug the mains plug into a wall socket.
3. Adjust the nursing bed as desired.

### Whenever the nursing bed is moved

- check the mains cable and plug for damage and kinks.
- route the mains cable in such a way that it cannot be pinched or rolled over.

## 7 Cleaning and Disinfection

### 7.1 Nursing Bed – Cleaning

- Clean using a damp cloth.
- Only use mild detergents without scouring agents to clean all metal parts and wooden and plastic surfaces.
- Never use sharp edged tools (knives, metal scrapers) or aggressive solvents for cleaning.
- Never use high-pressure cleaners for cleaning.
- Observe the instructions on how to use the detergents in order to avoid damage to the surfaces.

### 7.2 Nursing bed – Disinfection

If disinfection is required, only use suitable disinfectants.

## 8 Maintenance and Inspection

Hazards due to electrical and mechanical faults!

- Immediately remove faulty/defective nursing beds from operation and secure them against unauthorised use (disconnect the mains plug).
- Immediately show any defects to the responsible personnel.
- It is imperative that you always rectify any faults which could influence the function and safety of the nursing bed immediately.
- Observe the safety instructions contained in Chapter "2.1.5 Safety information – Maintenance and inspection" from page 4.

### 8.1 Maintenance – Daily

The daily maintenance work can be performed by the nursing personnel or carer:

- Lower both bed end actuator motors until they switch off automatically.
- Check the bed rails (option) for easy movement and damage.
- Check the correct function of the locking device on the bed rails (option).
- Clean using a damp cloth.

Whenever the nursing bed is moved:

- Check the mains cable and plug for damage and kinks.
- Route the mains cable in such a way that it cannot be pinched or rolled over.

### 8.2 Maintenance – Every six months

Check the control unit and handset

1. Test all handset adjustment functions. If an adjustment does not function properly, it is necessary to replace the handset or control unit.
2. Lock (disable) all handset adjustment functions.
3. Press all operating keys on the handset one after the other.
  - The actuator motors must not react.
  - If an adjustment functions in the lock-out mode (disabled), it is necessary to replace the handset or the control unit.

### 8.3 Maintenance – Safety inspections

#### 8.3.1 Testing intervals

Testing intervals are dependant on the type of usage of the nursing bed. Drive Devilbiss prescribes testing intervals of two years for safety inspections in accordance with MPBetriebV (Germany).

If beds are put back into use, inspections should take place before every new usage (after being assembled at the patient's location) and then every two years.

Testing intervals should be shortened if the nursing bed is subject to extensive use (for example due to frequent patient changes in nursing homes).

In case of doubt, please contact your Drive Devilbiss specialist dealer (see stamp on the back cover).

#### 8.3.2 Safety inspections – Mechanical components

All inspection work described below may only be carried out by expert trained and instructed personnel.

Evaluation of the checklist and repair of the nursing bed may only be carried out by expert personnel with suitable training, knowledge and experience.

Component	Evaluation	
	OK	defective
<b>Visual inspection of all frame and casing parts for deformation, damage, wear and corrosion</b>		
Mattress support (head/backrest and foot section) and its plastic elements	<input type="checkbox"/>	<input type="checkbox"/>
Head/backrest and foot section adjustment guides and bearings	<input type="checkbox"/>	<input type="checkbox"/>
Mattress support side panels	<input type="checkbox"/>	<input type="checkbox"/>
All components of the lifting device/scissor lifting device (if provided)	<input type="checkbox"/>	<input type="checkbox"/>
Casters	<input type="checkbox"/>	<input type="checkbox"/>
Check all connecting elements (nuts, screws/bolts, rivets etc.) for completeness, function and correct seating.	<input type="checkbox"/>	<input type="checkbox"/>
All casings	<input type="checkbox"/>	<input type="checkbox"/>
Casing seals	<input type="checkbox"/>	<input type="checkbox"/>
Casing screw seatings	<input type="checkbox"/>	<input type="checkbox"/>
Patient lifting pole mount	<input type="checkbox"/>	<input type="checkbox"/>
All patient lifting pole components	<input type="checkbox"/>	<input type="checkbox"/>
Head/backrest adjustment emergency unlocking, see page 4	<input type="checkbox"/>	<input type="checkbox"/>
Function of the engagement system	<input type="checkbox"/>	<input type="checkbox"/>
<b>Function test of the casters/wheel brakes</b>		
Easy running of the wheels (rolling and steering movements)	<input type="checkbox"/>	<input type="checkbox"/>
Wheel locking in "straight ahead" setting	<input type="checkbox"/>	<input type="checkbox"/>
Function and locking of the wheel brakes	<input type="checkbox"/>	<input type="checkbox"/>
<b>Mechanical testing of the patient lifting pole under load</b>		
Check the integrity/strength of the triangular hand grip	<input type="checkbox"/>	<input type="checkbox"/>
Check the integrity/strength of the hand grip straps	<input type="checkbox"/>	<input type="checkbox"/>
Check patient lifting pole tube for deformation under load	<input type="checkbox"/>	<input type="checkbox"/>

### 8.3.3 Safety inspections – Electrical components

Component	Evaluation	
	OK	defective
<b>Visual inspection of the electrical components</b>		
Mains cable for kinks and damage	<input type="checkbox"/>	<input type="checkbox"/>
Mains plug for damage	<input type="checkbox"/>	<input type="checkbox"/>
Handset cable for kinks and damage	<input type="checkbox"/>	<input type="checkbox"/>
Internal cabling for kinks and damage (especially at critical points such as cable leadthroughs, movable mattress support sections and the lifting device/height adjustment system)	<input type="checkbox"/>	<input type="checkbox"/>
Correct cable routing	<input type="checkbox"/>	<input type="checkbox"/>
Cables of the rechargeable battery (if provided) for kinks and damage	<input type="checkbox"/>	<input type="checkbox"/>

Component	Evaluation	
	OK	defective
<b>Correct seating and condition of the components</b>		
Plug contacts	<input type="checkbox"/>	<input type="checkbox"/>
Plug contact sealing rings	<input type="checkbox"/>	<input type="checkbox"/>
Cable leadthroughs	<input type="checkbox"/>	<input type="checkbox"/>
Cable fixings	<input type="checkbox"/>	<input type="checkbox"/>
Strain reliefs	<input type="checkbox"/>	<input type="checkbox"/>
Anti-kink sheaths	<input type="checkbox"/>	<input type="checkbox"/>
<b>Function test of the electrical components</b>		
Test the limit switches of the actuator motors by running all adjustments up as far as the limit positions The limit switches are operating correctly if the switching noise in the switch-off relays can be heard	<input type="checkbox"/>	<input type="checkbox"/>
<b>Function test of the actuator motors</b>		
Unusual noises	<input type="checkbox"/>	<input type="checkbox"/>
Adjusting speed	<input type="checkbox"/>	<input type="checkbox"/>
<b>Handset function test</b>		
Functions	<input type="checkbox"/>	<input type="checkbox"/>
Easy movement	<input type="checkbox"/>	<input type="checkbox"/>
Damage	<input type="checkbox"/>	<input type="checkbox"/>



### 8.3.4 Safety inspections – Measurement in accordance with BGV A3

Some countries in the European Union have a legal requirement to carry out the measurements listed below (in Germany in accordance with VDE 0751-1).

The nursing bed owner is responsible for determining the appropriate national regulations.

All measurements described below may only be carried out by expert trained and instructed personnel with the use of suitable measuring instruments. Any detected faults must be rectified by the expert person immediately.



**Hazards due to electrical and mechanical faults!**

Immediately remove faulty/defective nursing beds from operation and secure them against unauthorised use (disconnect the mains plug).



**Risk of accidents!**

It is imperative that you always rectify any faults which could influence the function and safety of the nursing bed immediately.

Component	Evaluation	
	OK	defective
<i>The following measurements must be carried out in accordance with DIN VDE 0751-1:</i>		
Protective conductor resistance (only Class I devices)	<input type="checkbox"/>	<input type="checkbox"/>
Equivalent leakage currents	<input type="checkbox"/>	<input type="checkbox"/>

**Information about measurement of equivalent leakage currents:**

- Typical value: < 20 µA
- Measurement locations: Shorted-out mains plug (L+N) against
  - ✎ metallic parts of the bed end actuator motors
  - ✎ bare/unpainted, metallic points of the bed frame (screws etc.)

## 9 Trouble shooting

Fault	Cause	Remedy
The mattress support head/backrest or the bed frame cannot be raised/ lowered	Mains plug not plugged in	see page 17
	Handset disabled	see page 14 see page 15
	Thermal switch active	Try again after 20 to 30 minutes
	Handset defective	Inform your specialist dealer
Control unit defective		
Mattress support foot section does not engage when raised	Engagement system defective	Inform your specialist dealer
Swivel wheels cannot be locked	Swivel wheel defective	Inform your specialist dealer
	Wheel brake defective	
Handset control lamp does not light up when actuated	Handset disabled	see page 14 see page 15
	Handset defective	Inform your specialist dealer
	Maximum drive load exceeded	Reduce drive load
	Control unit defective	Inform your specialist dealer

## 10 Reuse

Casabeds are designed for reuse.

They must be cleaned and disinfected prior to reuse.

If disinfection is required, only use suitable disinfectants.

## 11 Disposal

Nursing beds consist of:

- Metal parts
- Plastic parts
- Electronic components
- Electric cables
- Rechargeable batteries/batteries

Disposal of the individual materials must be carried out in accordance with the valid regional environmental and disposal regulations.

Nursing beds are not to be disposed of with household waste; they must be taken to local waste collection depots.

Electronic components, electric cable and rechargeable batteries/batteries are not to be disposed of with household waste but taken to the stipulated waste disposal depot and disposed of in accordance with the regulations.



### Note

*If you have any questions regarding disposal please consult your local waste disposal depot or your Drive Medical specialist dealer.*



## 12 Appendix

### 12.1 Technical data

#### 12.1.1 Technical data – Nursing bed

CE certification in accordance with 93/42/EEC and all its amendments

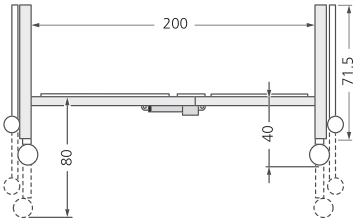
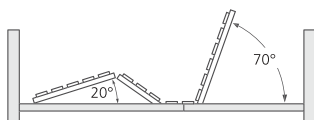
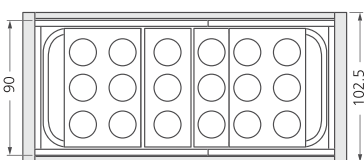
Designation	Value	Dimensions (cm)
<b>Max. occupant weight</b>	140.0 kg	
<b>Max. working load</b>		
Nursing bed (*1)	175.0 kg	
Patient lifting pole	125 kg	
<b>Weights</b>		
Total weight: Classic FS	107.6 kg	
Mattress support, head/backrest	17.5 kg	
Bed end, headboard	25.4 kg	
Bed end, footboard	25.4 kg	
Patient lifting pole	7.0 kg	
Control unit	1.8 kg	
Actuator motor (each)	2.1 kg	
Handset	0.3 kg	
<b>Mattress to be used (*2)</b>		
<b>Dimensions</b> (width x length x height)	90 x 200 x 12.7cm or 90 x 200 x 15.2cm	
<p>Other Drive Devilbiss mattresses available upon request - contact your provider or Drive Devilbiss to check for compatibility and suitability</p>		

#### 12.1.2 Technical data – Drive system

Designation	Value
Power supply (where fuse is required - use 5 amp)	230 VAC; 50Hz/60Hz
Protection class	II
Protection type	IP44
Noise level	<65 dB(A)
Maximum continuous operation of the actuator motors	2 minutes
Minimum pause after 2 minutes operation	18 minutes
Actuator motor lift	
Bed end (headboard)	85 mm
Bed end (footboard)	85 mm
Operating conditions – ambient temperature	+10°C to +40°C
Operating conditions – relative humidity	30% to 75%
Storage humidity	30% to 75%

## Atmospheric Pressure Range

RATED operating altitude (a) m	Normal barometric pressure kPa
a ≤ 2 000	80.0

<b>Additional Information</b> – <b>Electromagnetic compatibility</b> – (*IEC/EN 60601-1-2)
<b>Additional information intended to be used by the end-product manufacturer</b> (See *IEC/EN 60601-1-2)
Additional information intended to be used with DEWERT actuator system consists of DEWERT product(s), such as:
<ul style="list-style-type: none"> <li>• <b>Control Unit, e.g. MC10, MC11, MCL, MCL II</b></li> <li>• <b>Single Drive, e.g. MEGAMAT MCZ, DS10</b></li> </ul>
The above described DEWERT system consists of DEWERT product(s) is/are hereinafter called <b>PRODUCT</b> .
<p>* Standard(s):</p> <ul style="list-style-type: none"> <li>• IEC 60601-1-2:2007</li> <li>• EN 60601-1-2:2007</li> </ul> <p>The standards (see above) hereinafter called IEC/EN 60601-1-2</p>

1	<b>Guidance and manufacturer's declaration</b> – <b>Electromagnetic Emissions</b> – (*IEC/EN 60601-1-2, Table 1)  * edition: see page 1 – standard(s)		
2	The PRODUCT is intended for use in the electromagnetic environment specified below. The customer or the user of the PRODUCT should assure that it is used in such an environment.		
3	<b>Emissions test</b>	<b>Compliance</b>	<b>Electromagnetic environment – guidance</b>
4	RF emissions CISPR 11	Group 1	The PRODUCT uses RF energy only for its internal function. Therefore, its RF emissions are very low and are not likely to cause any interference in nearby electronic equipment.
6	RF emissions CISPR 11	Class B	The PRODUCT is suitable for use in all establishments, including domestic establishments and those directly connected to the public lowvoltage power supply network that supplies buildings used for domestic purposes.
7	Harmonic emissions IEC 61000-3-2	Class A	
8	Voltage fluctuations/ flicker emissions IEC 61000-3-3	Complies	



**Guidance and manufacturer's declaration**  
**– Electromagnetic Immunity –**

(\*IEC/EN 60601-1-2, Table 2)

\* edition: see page 1 – standard(s)

The PRODUCT is intended for use in the electromagnetic environment specified below. The customer or the user of the PRODUCT should assure that it is used in such an environment.

Immunity test	IEC 60601 test level	Compliance level	Electromagnetic environment – guidance
Electrostatic discharge (ESD) IEC 61000-4-2	± 6 kV contact  ± 8 kV air	± 6 kV contact  ± 8 kV air	Floors should be wood, concrete or ceramic tile. If floors are covered with synthetic material, the relative humidity should be at least 30 %.
Electrical fast transient/burst IEC 61000-4-4	± 2 kV for power supply lines  ± 1 kV for input/output lines	± 2 kV  Not applicable	Mains power quality should be that of a typical commercial or hospital environment.
Surge IEC 61000-4-5	± 1 kV line(s) to line(s)  ± 2 kV line(s) to earth	± 1 kV  ± 2 kV	Mains power quality should be that of a typical commercial or hospital environment.
Voltage dips, short interruptions and voltage variations on power supply input lines IEC 61000-4-11	<5% $U_T$ (>95% dip in $U_T$ ) for 0,5 cycle  40% $U_T$ (60% dip in $U_T$ ) for 5 cycles  70% $U_T$ (30% dip in $U_T$ ) for 25 cycles  <5% $U_T$ (>95% dip in $U_T$ ) for 5 s	<5% $U_T$  40% $U_T$  70% $U_T$  <5% $U_T$	Mains power quality should be that of a typical commercial or hospital environment.  If the user of the PRODUCT requires continued operation during power mains interruptions, it is recommended that the PRODUCT be powered from an uninterruptible power supply or a battery.
Power frequency (50/60 Hz) magnetic field  IEC 61000-4-8	3 A/m	3 A/m	Power frequency magnetic fields should be at levels characteristic of a typical location in a typical commercial or hospital environment.

NOTE:  $U_T$  is the a.c. mains voltage prior to application of the test level.



**Guidance and manufacturer's declaration  
– Electromagnetic Immunity –**

**for life supporting equipment and systems**

(\*IEC/EN 60601-1-2, Table 3)

\* edition: see page 1 – standard(s)

The PRODUCT is intended for use in the electromagnetic environment specified below. The customer or the user of the PRODUCT should assure that it is used in such an environment.

Immunity test	IEC 60601 test level	Compliance level	Electromagnetic environment – guidance
<p>Conducted RF IEC 61000-4-6</p> <p>Radiated RF IEC 61000-4-3</p>	<p>3 V<sub>rms</sub> 150 kHz to 80 MHz outside ISM bands<sup>a</sup></p> <p>10 V<sub>rms</sub> 150 kHz to 80 MHz in ISM bands<sup>a</sup></p> <p>10 V/m 80 MHz to 2,5 GHz</p>	<p>3 V<sub>rms</sub></p> <p>10 V<sub>rms</sub></p> <p>10 V/m</p>	<p>Portable and mobile RF communications equipment should be used no closer to any part of the PRODUCT, including cables, than the recommended separation distance calculated from the equation applicable to the frequency of the transmitter</p> <p><b>Recommended separation distance:</b> d = 1,2 (P)<sup>1/2</sup></p> <p>d = 1,2 (P)<sup>1/2</sup></p> <p>d = 1,2 (P)<sup>1/2</sup>     80 MHz to 800 MHz d = 2,3 (P)<sup>1/2</sup>     800 MHz to 2,5 GHz</p> <p>where P is the maximum output power rating of the transmitter in watts (W) according to the transmitter manufacturer and d is the recommended separation distance in metres (m).<sup>b</sup></p> <p>Field strengths from fixed RF transmitters, as determined by an electromagnetic site survey<sup>c</sup>, should be less than the compliance level in each frequency range<sup>d</sup>.</p> <p>Interference (from a mobile phone for example), may occur in the vicinity of equipment marked with the following symbol: </p>

NOTE 1: At 80 MHz and 800 MHz, the higher frequency range applies.

NOTE 2: These guidelines may not apply in all situations. Electromagnetic propagation is affected by absorption and reflection from structures, objects and people.

<sup>a</sup> The ISM (industrial, scientific and medical) bands between 150 kHz and 80 MHz are 6,765 MHz to 6,795 MHz; 13,553 MHz to 13,567 MHz; 26,957 MHz to 27,283 MHz; and 40,66 MHz to 40,70 MHz.

<sup>b</sup> The compliance levels in the ISM frequency bands between 150 kHz and 80 MHz and in the frequency range 80 MHz to 2,5 GHz are intended to decrease the likelihood that mobile/portable communications equipment could cause interference if it is inadvertently brought into patient areas. For this reason, an additional factor of 10/3 has been incorporated into the formulae used in calculating the recommended separation distance for transmitters in these frequency ranges.

<sup>c</sup> Field strengths from fixed transmitters, such as base stations for radio (cellular/cordless) telephones and land mobile radios, amateur radio, AM and FM radio broadcast and TV broadcast cannot be predicted theoretically with accuracy. To assess the electromagnetic environment due to fixed RF transmitters, an electromagnetic site survey should be considered. If the measured field strength in the location in which the PRODUCT is used exceeds the applicable RF compliance level above, the PRODUCT should be observed to verify normal operation. If abnormal performance is observed, additional measures may be necessary, such as re-orienting or relocating the PRODUCT..

<sup>d</sup> Over the frequency range 150 kHz to 80 MHz, field strengths should be less than 3 V/m.



<b>Guidance and manufacturer's declaration</b> <b>- Electromagnetic Immunity -</b> <b>(*IEC/EN 60601-1-2, Table 2)</b>			
* edition: see page 1 – standard(s)			
The PRODUCT is intended for use in the electromagnetic environment specified below. The customer or the user of the PRODUCT should assure that it is used in such an environment.			
Immunity test	IEC 60601 test level	Compliance level	Electromagnetic environment – guidance
Electrostatic discharge (ESD) IEC 61000-4-2	± 6 kV contact  ± 8 kV air	± 6 kV contact  ± 8 kV air	Floors should be wood, concrete or ceramic tile. If floors are covered with synthetic material, the relative humidity should be at least 30 %.
Electrical fast transient/burst IEC 61000-4-4	± 2 kV for power supply lines  ± 1 kV for input/output lines	± 2 kV  Not applicable	Mains power quality should be that of a typical commercial or hospital environment.
Surge IEC 61000-4-5	± 1 kV line(s) to line(s)  ± 2 kV line(s) to earth	± 1 kV  ± 2 kV	Mains power quality should be that of a typical commercial or hospital environment.
Voltage dips, short interruptions and voltage variations on power supply input lines IEC 61000-4-11	<5% $U_T$ (>95% dip in $U_T$ ) for 0,5 cycle  40% $U_T$ (60% dip in $U_T$ ) for 5 cycles  70% $U_T$ (30% dip in $U_T$ ) for 25 cycles  <5% $U_T$ (>95% dip in $U_T$ ) for 5 s	<5% $U_T$  40% $U_T$  70% $U_T$  <5% $U_T$	Mains power quality should be that of a typical commercial or hospital environment.  If the user of the PRODUCT requires continued operation during power mains interruptions, it is recommended that the PRODUCT be powered from an uninterruptible power supply or a battery.
Power frequency (50/60 Hz) magnetic field  IEC 61000-4-8	3 A/m	3 A/m	Power frequency magnetic fields should be at levels characteristic of a typical location in a typical commercial or hospital environment.
NOTE: $U_T$ is the a.c. mains voltage prior to application of the test level.			



### Guidance and manufacturer's declaration

## Recommended separation distances between portable and mobile RF communications equipment and the PRODUCT for life supporting equipment and systems

(\*IEC/EN 60601-1-2, Table 5)

\* edition: see page 1 – standard(s)

The PRODUCT is intended for use in an electromagnetic environment in which radiated RF disturbances are controlled. The customer or the user of the PRODUCT can help prevent electromagnetic interference by maintaining a minimum distance between portable and mobile RF communications equipment (transmitters) and the PRODUCT as recommended below, according to the maximum output power of the communications equipment.

Rated maximum output power of transmitter [W]	Separation distance (d) according to frequency of transmitter [m]			
	150 kHz to 80 MHz outside ISM bands $d = 1,2 (P)^{1/2}$	150 kHz to 80 MHz in ISM bands $d = 1,2 (P)^{1/2}$	80 MHz to 800 MHz $d = 1,2 (P)^{1/2}$	800 MHz to 2,5 GHz $d = 2,3 (P)^{1/2}$
0,01	0,12	0,12	0,12	0,23
0,1	0,38	0,38	0,38	0,73
1	1,2	1,2	1,2	2,3
10	3,8	3,8	3,8	7,3
100	12	12	12	23

For transmitters rated at a maximum output power not listed above, the recommended separation distance d in metres (m) can be determined using the equation applicable to the frequency of the transmitter, where P is the maximum output power rating of the transmitter in watts (W) according to the transmitter manufacturer.

NOTE 1: At 80 MHz and 800 MHz, the separation distance for the higher frequency range applies.

NOTE 2: The ISM (industrial, scientific and medical) bands between 150 kHz and 80 MHz are 6,765 MHz to 6,795 MHz; 13,553 MHz to 13,567 MHz; 26,957 MHz to 27,283 MHz; and 40,66 MHz to 40,70 MHz.

NOTE 3: An additional factor of 10/3 has been incorporated into the formulae used in calculating the recommended separation distance for transmitters in the ISM frequency bands between 150 kHz and 80 MHz and in the frequency range 80 MHz to 2.5 GHz to decrease the likelihood that mobile/portable communications equipment could cause interference if it is inadvertently brought into patient areas.

NOTE 4: These guidelines may not apply in all situations. Electromagnetic propagation is affected by absorption and reflection from structures, objects and people.

**Guidance and manufacturer's declaration**  
**Recommended separation distances between**  
**portable and mobile RF communications equipment and the PRODUCT**  
**for not life supporting equipment and systems**  
 (\*IEC/EN 60601-1-2, Table 6)

\* edition: see page 1 – standard(s)

The PRODUCT is intended for use in an electromagnetic environment in which radiated RF disturbances are controlled. The customer or the user of the PRODUCT can help prevent electromagnetic interference by maintaining a minimum distance between portable and mobile RF communications equipment (transmitters) and the PRODUCT as recommended below, according to the maximum output power of the communications equipment.

Rated maximum output power of transmitter [W]	Separation distance (d) according to frequency of transmitter [m]		
	150 kHz to 89 MHz	90 MHz to 800 MHz	800 MHz to 2,5 GHz
	$d = 1,2 (P)^{0,2}$	$d = 0,4 (P)^{0,2}$	$d = 0,7 (P)^{0,2}$
0,01	0,12	0,04	0,1
0,1	0,38	0,13	0,22
1	1,2	0,4	0,7
10	3,8	1,3	2,21
100	12	4	7

For transmitters rated at a maximum output power not listed above, the recommended separation distance  $d$  in metres (m) can be estimated using the equation applicable to the frequency of the transmitter, where  $P$  is the maximum output power rating of the transmitter in watts (W) according to the transmitter manufacturer.

NOTE 1: At 80 MHz and 800 MHz, the separation distance for the higher frequency range applies.

NOTE 2: These guidelines may not apply in all situations. Electromagnetic propagation is affected by absorption and reflection from structures, objects and people.



**Additional Information**  
**– Electromagnetic compatibility –**  
**(\*IEC/EN 60601-1-2)**

Date: February 27, 2013  
REV.: 00  
Made by: W. Kracht

**Additional information intended to be used by the end-product manufacturer**  
**(See \*IEC/EN 60601-1-2)**

Additional information intended to be used with DEWERT actuator system consists of DEWERT component(s)/product(s):

- **Handset IPROXX**

The above described component(s)/product(s) is/are hereinafter called **PRODUCT**.

**NOTE:** These instructions are only intended to be used by the end-product manufacturer. They should not be given to the operator of the end product. The factual information contained within may be used as a basis when creating the end-product manual.

Observe the document "Installation instruction" of **PRODUCT** (see above).

- \* Standard(s):
- IEC 60601-1-2:2007
  - EN 60601-1-2:2007

The standards (see above) hereinafter called IEC/EN 60601-1-2



**Guidance and manufacturer's declaration**  
**– Electromagnetic Immunity –**  
**for not life supporting equipment and systems**

(IEC/EN 60601-1-2, Table 4)

\* edition: see page 1 – standard(s)

The PRODUCT is intended for use in the electromagnetic environment specified below. The customer or the user of the PRODUCT should assure that it is used in such an environment.

Immunity test	IEC 60601 test level	Compliance level	Electromagnetic environment – guidance
Conducted RF IEC 61000-4-6	3 V <sub>eff</sub> 150 kHz to 80 MHz	3 V <sub>eff</sub>	Portable and mobile RF communications equipment should be used no closer to any part of the PRODUCT, including cables, than the recommended separation distance calculated from the equation applicable to the frequency of the transmitter.  <b>Recommended separation distance:</b> $d = 1,2 (P)^{0,2}$
Radiated RF IEC 61000-4-3	3 V/m 80 MHz to 2500 MHz	10 V/m	$d = 0,4 (P)^{0,2}$ 80 MHz to 800 MHz $d = 0,7 (P)^{0,2}$ 800 MHz to 2,5 GHz  where <b>P</b> is the maximum output power rating of the transmitter in watts (W) according to the transmitter manufacturer and <b>d</b> is the recommended separation distance in metres (m).  Field strengths from fixed RF transmitters, as determined by an electromagnetic site survey <sup>a</sup> should be less than the compliance level in each frequency range <sup>b</sup> .  Interference (from a mobile phone for example), may occur in the vicinity of equipment marked with the following symbol: 

NOTE 1: At 80 MHz and 800 MHz, the higher frequency range applies.

NOTE 2: These guidelines may not apply in all situations. Electromagnetic propagation is affected by absorption and reflection from structures, objects and people.

- <sup>a</sup> Field strengths from fixed transmitters, such as base stations for radio-(cellular/cordless) telephones and land mobile radios, amateur radio, AM and FM radio broadcast and TV broadcast cannot be predicted theoretically with accuracy. To assess the electromagnetic environment due to fixed RF transmitters, an electromagnetic site survey should be considered. If the measured field strength in the location in which the PRODUCT is used exceeds the applicable RF compliance level above, the PRODUCT should be observed to verify normal operation. If abnormal performance is observed, additional measures may be necessary, such as re-orienting or relocating the PRODUCT.
- <sup>b</sup> Over the frequency range 150 kHz to 80 MHz, field strengths should be less than 3 V/m.

## 12.2 Name plate

### 12.2.1 Name plate – Nursing bed

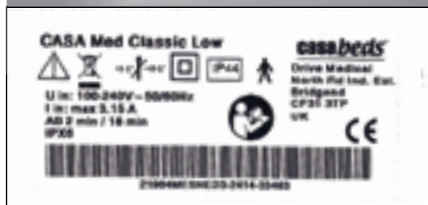
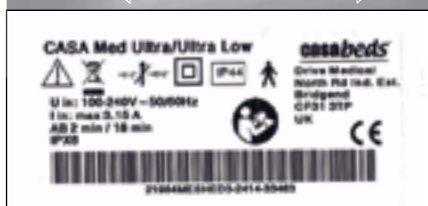
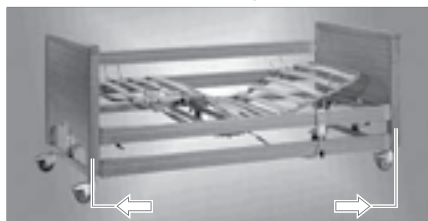

same data would apply to Casa Med Ultra, Ultra FS, Casa Med Classic Low. However name would change.

The name plate is attached to the end of the nursing bed and indicates the following data:

Protection class II (protective insulation)	
CE certification in accordance with 93/42/EEC	
Type B Applied Part	
Degree of Protection	<b>IP44</b>
Caution! Observe the operating manual	
Maximum continuous operation of the actuator motors = 2 minutes 18 minutes minimum pause after 2 minutes	
Note on disposal	
On ME Equipment 'follow instructions for use'.	

### 12.2.3 Name plate – maximum patient weight & safe working load

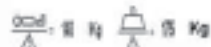

The name plate is attached to the mattress support

### 12.2.4 Name plate – Detachable Parts of a medical bed of a mass of more than 20 Kg



The name plate is attached to the head and foot posts.

### 12.2.5 name plate – Replacement Mattresses

Incompatible mattresses can create hazards. Read the instructions for use.

Name plate is attached to the mattress support.

### 12.3 Accessories and options

Please contact your Drive Devilbiss specialist dealer (see dealer stamp on the back cover) to order any of the articles.

Designation	Order No.
9S Bed Rails Silver Casa Nuova, pair 'optional metal'	9SLBE
Transport and storage system	16105BE
Triangular hand grip with length adjustable belt	21873BE

### 12.4 Spare parts

Only use original spare parts from Drive Devilbiss



#### Note

*If you need any spare parts, please contact your Drive Devilbiss specialist dealer (see dealer stamp on back cover).*

## 13 Warranty information

The Casabeds range<sup>1</sup> carries a 3 year warranty (Parts Only) from date of purchase.

#### Important!

- During the warranty period any parts that have become defective due to faulty workmanship or material will be repaired or replaced without charge by Drive Devilbiss supplier / dealer.
- The warranty excludes all items that have been subject to undue wear and items subjected to misuse.
- Unauthorized changes or modifications will forfeit your warranty.
- If a defect or fault is discovered, the Drive Devilbiss supplier / dealer from whom the electric bed was purchased should be notified immediately.

#### Limitation of liability

The warranty does not extend to the consequential costs resulting from fault clearance, in particular freight and travel costs, loss of earnings, expenses, etc.

The manufacturer will not accept responsibility for any damage or injury caused by misuse or non-observance of the instructions set out in this user manual

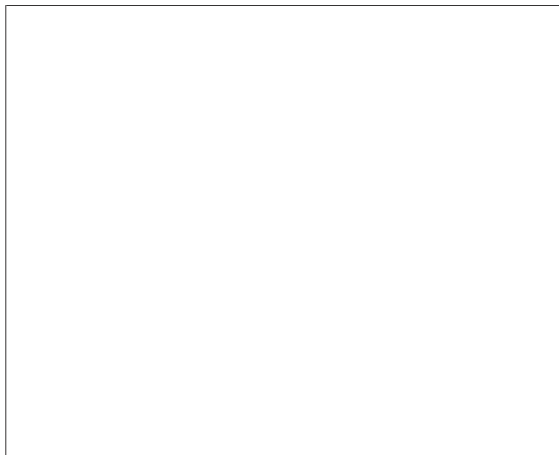

**casa***beds*<sup>TM</sup>

---

**Drive Devilbiss Healthcare**

North Road  
Bridgend Industrial Estate  
Bridgend  
CF31 3TP

(t) + 044 1656 66 47 00

(f) + 044 1656 66 47 27

(e) [info@drivedevilbiss.co.uk](mailto:info@drivedevilbiss.co.uk)

(w) [www.drivedevilbiss.co.uk](http://www.drivedevilbiss.co.uk)